



# Quality Tractor Parts

## ZETOR



## Contents

<b>Engine</b>	<b>ZET 3</b>		
Gaskets	ZET 3		
Fuel	ZET 4		
Exhausts	ZET 5		
Cooling	ZET 7		
<b>Filters</b>	<b>ZET 9</b>		
Individual Filters	ZET9		
<b>Axle Parts</b>	<b>ZET 10</b>		
Track Rod Ends	ZET 10		
2WD & 4WD Axle	ZET 11		
<b>Cab, Sheet Metal &amp; Electrical</b>	<b>ZET 13</b>		
Cab	ZET 13		
Lamps & Grills	ZET 15		
Glass	ZET 22		
<b>Clutch, Transmission &amp; PTO</b>	<b>ZET 27</b>		
Individual Clutch Parts	ZET 27		
Clutch Kits	ZET 27		
<b>Brakes, Hydraulics &amp; Linkage</b>	<b>ZET 30</b>		
Brakes	ZET 30		
Hydraulic Pumps	ZET 34		
Lift & Linkage	ZET 35		

## Gasket Sets

**3031**



4712/18 Complete Gasket Set

**5323**



Sump Set Zetor 7520-10520, 7540-10540

**5324**

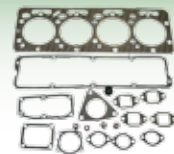

Head Set Zetor 7520-10520, 7540-10540

**3111**

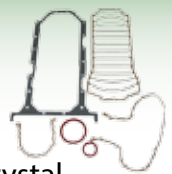

Zetor Crystal Sump Set

## Individual Head Gaskets

**5317**



Head Gasket Zetor (1.2/110/9 Hole)

**1593**



Zetor 4712/18 Head Gasket (110mm)

**2359**



Head Gasket Zetor (1.2/8 Hole/106mm)

**5079**



Zetor 8011 Centre Housing Gasket

## Manifold Exhaust Gaskets

**5047**



Zetor 8011 Manifold Exhaust Gasket

**5048**



Zetor 8111 Manifold Exhaust Gasket

**1339**



Zetor Exhaust Manifold Gasket

## Sump Gasket

**2360**



Zetor 5711/18/45/48 Sump Gasket

## Timing Sump Gasket

**3035**



Zetor 8011 Timing Sump Gasket

## Water Pump Gasket

**3614**



Zetor 8011 Water Pump Gasket

## Rocker Cover Gasket

**5318**



Rocker Cover Gasket for Zetor

## Timing Cover Seal

**3040**



Timing Cover Seal Zetor 8011

## Crankshaft Oil Seal

**3036**



Rear Crankshaft Oil Seal Zetor 8011

## Crankshaft Bearing

**5078**



8011 Crankshaft Bearing

## Crankshaft Pulley

**5039**



8011 Crankshaft Pulley

# Engine

## Fuel Components

### Priming Pump

### Fuel Lift Pumps

**5016**



8011/8111  
Priming Pump

**5124**



5011/5211/6011/6045/  
7011/7045 Fuel  
Lift Pump (3 holes )

**5009**



Zetor 8011/8111  
Fuel Lift Pump  
(2 holes )

### Fuel Cap

### Fuel Tank Cap

**59677**



Fuel Cap Zetor  
Major Series

**2503**



Fuel Tank Cap Zetor  
6718 8011

### Fuel Pipes



**7186**  
Zetor 5718-7045  
Body for Glass  
Bowl



**2505**  
Fuel Bowl  
Filter



**7187**  
Spring for Glass  
Bowl



**5004**  
Glass Bowl  
Zetor

**7176**

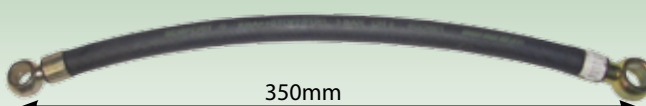

Zetor 5211-7745 Fuel Pipe from L/P  
to filters Twin Filters

**7175**



Zetor 5211-7745 Fuel Pipe from filter  
to Inj. Pipe (Single Filter)

## Exhausts & Manifolds

### Manifold

### Gasket

### Elbow

### Eye Bolts

**1991**



Zetor 8011/8145  
Air Intake Manifold

**5180**



Zetor Gasket  
for Exhaust

**5181**



Zetor Eye Bolts  
for Exhaust

## Exhausts

**1414**



Exhaust Zetor 8011  
/Ursus 385 - Black

**1889**



Exhaust Zetor  
Unified Black Swan

**5030**

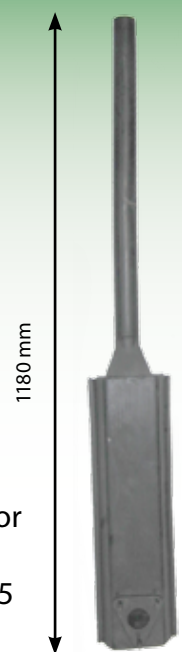

Exhaust Zetor  
8111/8145/  
12111/12145

**5042**



Exhaust Zetor  
12145 Upright

**7166**



Exhaust Zetor  
6211-7245  
(2 Hook Type)

## Hoses Clips Original Type



Part No	Diameter (""")	Diameter (mm)
50985	2 3/4" - 3 1/2"	70-90
50986	2 3/8" - 3 3/16"	60-80
50987	2" - 2 3/4"	50-70
50990	1 3/16" - 1 3/4"	30-45
50991	1 1/8" - 1 7/8"	28-48
50992	7/8" - 1 3/16"	23-36
50995	23/32" - 1"	18-26mm
50996	5/8" - 1"	16-25
50997	15/32" - 3/4"	12-20
50998	3/8" - 5/8"	10-16
50999	5/16" - 15/32"	8-12

## Small Hose Clips

Part No	Diameter (mm)
59659	11
59660	13
59658	14
59661	17



## Heavy Duty Clamp

Part No	Diameter (mm)
51934	122 - 130
51933	113 - 121







## Standard Type



Part No	Diameter (mm)	TYPE
2340	8-12	
2340SS	9.5-12	Stainless Steel
2345	10-16	
2345SS	11-15	Stainless Steel
2346	12-20	
2346SS	12-20	Stainless Steel
2357	16-25	
2357SS	16-22	Stainless Steel
2364	18-26	
2364SS	18 - 25	Stainless Steel
2393	19-26	
2394	23-35	
2394SS	25- 35	Stainless Steel
2395	23-36	
2396	28-48	
2397	28-48	
2397SS	30 40	Stainless Steel
2413	32-50	
2413SS	35-50	Stainless Steel
2426	40-60	
2426SS	45-60	Stainless Steel
2440	50-70	
2440SS	55-70	Stainless Steel
2441	60-80	
2441SS	60-80	Stainless Steel
2443	70-90	
2443SS	70-90	Stainless Steel

## Cooling System Hose Radiator Bottom

<p><b>4209</b></p> 	<p><b>4208</b></p> 	<p><b>4210</b></p> 	<p><b>4385</b></p> 	<p><b>5326</b></p> 
<p>Zetor 8011 8045 - Straight Hose Radiator Bottom</p>	<p>Zetor Crystal Bottom Hose</p>	<p>Hose Zetor Crystal Bottom Hose</p>	<p>Hose Radiator Zetor Bottom Curved</p>	<p>Hose Bottom Zetor 2011 to 7745</p>

## Hose Radiator Top

<p><b>4384</b></p> 	<p><b>4383</b></p> 
<p>Hose Radiator Zetor 8011 Top</p>	<p>Hose Radiator Zetor 12011 Top</p>

## Fanblade

<p><b>5028</b></p>  <p>Fanblade Zetor 8111 - 4 Blade</p> <p>455 mm</p>
---

## Radiator Cap

<p><b>5029</b></p>  <p>Radiator Cap Zetor 8011</p>
--

## Thermostat

<p><b>5107</b></p>  <p>Thermostat Zetor 8011</p>
---



Part No	Models	OE Ref	Size
<b>2255</b>	Fan Belt Zetor Crystal	98419479	13 X 1275
<b>1237</b>	Fan Belt Zetor 8111		10 X 1225
<b>B45</b>	Fan Belt Zetor - up to 6718	974312 974318	
<b>59685</b>	Fan Belt Zetor 10 x 1113 - V Belt		10 X 1113
<b>59686</b>	Fan Belt Zetor V Belt	53013904	10 X 1125

# Engine

## Cooling System

### Water Pump

**5164**



Zetor 6 Cylinder  
Water Pump

**5163**



Unified Range  
Water Pump

**5320**



Water pump Zetor  
unified-1 outlet

### Water Pump & Gasket

**5000**



Zetor crystal / 8011  
Water pump

**7179**



Zetor 8011-8045  
Water Pump Gasket

**5001**



Zetor  
8111/10211/8045  
Water Pump

**7178**



Zetor 8111-10145  
Water Pump Gasket

### Water Pump Gaskets

**7177**



Zetor 5011-7745  
Water Pump Gasket

**3614**

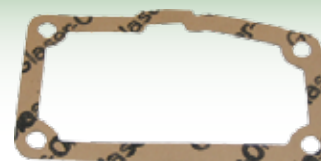

Water Pump  
Gasket Zetor

### Water Pump Bearing

**2506**



Zetor  
Water Pump Seal

**62032RS**



Zetor  
Water Pump Bearing



## Individual Filters

### Fuel Filters

**2192**

Overall height =135mm  
OD=80mm



Fuel Filter Zetor  
8011 New Type

**1682**

Overall height =105mm  
OD=65mm



Fuel Filter Zetor  
Crystal / Farmtrac

**1684**

Overall height =125mm  
OD=70 mm



Fuel Filter  
Zetor Secondary

**5159**

Overall height =140mm  
OD=85mm



Fuel Filter  
Zetor 9540

### Air Filters

**1446**

Overall height =210mm  
OD=200mm



Air Filter Zetor

**5156**

Overall height =380mm  
OD=200mm

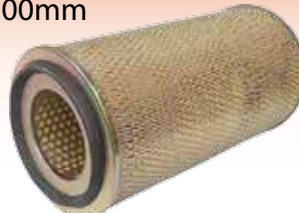

Air Filter Zetor 9540

**5157**

Overall height =375mm  
OD=100mm

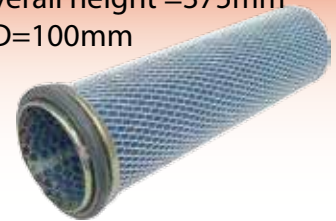

Air Filter Zetor 9540 Inner

### Engine Oil Filters

**5053**



9540  
Engine Oil Filter

**7159**



Engine Oil Filter Zetor  
10111-12045/  
8011-8045

**5184**



5184  
Engine Oil Filter  
Zetor Super for 5341

### Torque Filter

**5017**

Overall height =120mm  
OD=100mm



Torque Hydraulic  
Filter Zetor

### Hydraulic Filters

**51894**



Hydraulic Filter Zetor  
7321T Proxima  
6441 7441 8441

**5155**

Overall height =140mm  
OD=80mm



Hydraulic Filter  
Zetor 9540

**1685**



Crystal Spin on  
Hydraulic Oil Filter

**5300**

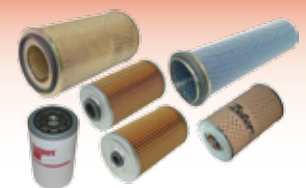

Filter Kit Zetor 9540

# Axle Parts

## Track Rod Ends Unified Range

**1221**



Track Rod End  
Zetor 4011 LH

**3918**



Track Rod End  
Zetor Unified LH  
(LH Thread)

**3919**

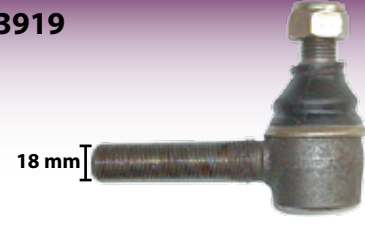

Track Rod End  
Zetor Unified RH  
(RH Thread)

## Crystal 2WD

**3917**



Track Rod End Zetor Crystal LH

**3916**



Track Rod End Zetor  
Crystal RH Ursus

## Crystal 4WD

**3921**

Track Rod End Zetor LH  
4WD HD



**3920**

Track Rod End Zetor  
RH 4WD HD

**5185**

Track Rod End Zetor  
9540 4WD LH



**5186**

Track Rod End Zetor  
9540 4WD RH

## Front Wheel Studs

**1228**

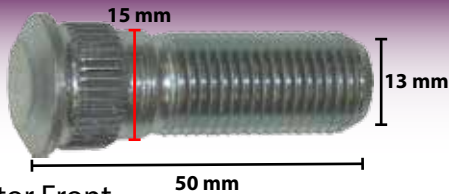

Wheel Stud Zetor Front

**1229**



Wheel Nut Zetor Front

## Wheel Bearings

**1884**

Wheel Bearing Kit Zetor 8011

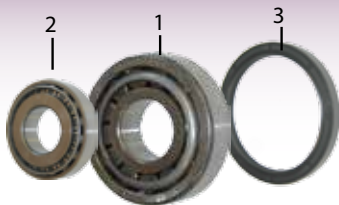

1. **30309J** Zetor 8011 Inner Roller Bearing
2. **30305** Outer Roller Bearing Zetor 8011
3. **1654** Seal Zetor 8011 part of kit 1884

## Pivot Bearing

**32307**



Pivot Bearing  
Zetor 4WD

## Universal Joint

**2315**



Universal Joint  
38 x 105.8mm

## Universal Joint Carrier

**5106**



Universal Joint  
Carrier Zetor  
8011 4WD

## Front Axle Components Line Header

**2509**  
44 mm

Washer Zetor  
Steering Back-up

**5067**

Hub Cap Zetor 8011

**5098**  
Steering Bolt  
Zetor 8011 45 x 50

**5086**  
Steering U Joint Pin  
Zetor 8011

**5088**  
Steering Wheel  
Zetor 8011

**51109** Spindle Bearing 65x45  
**51108** Spindle Bearing 60x40  
**51107** Spindle Bearing 52x35

**7155**

Zetor 4WD Engagement Cable

## Power Steering Shaft

**52818**

Power  
Steering Shaft

## Power Steering Pump

**3281**

8011 Power  
Steering Pump

## Seal Kit

**7182**

Power Steering Rack Seal  
Kit Zetor crystal

**5082**  
Front Axle Pin  
Bush Zetor 8011

**5083**  
Front Axle Nut  
Zetor 8011

**5084**  
Front Axle Pin Bush  
Zetor 8011

**5113**  
Front Axle Pin Zetor 8011

**5125**  
Front Axle Pin Washer  
Zetor 8011 4WD

**5127**  
Front Axle Pin Bush  
Zetor 8011 4WD

# Orbital Units

**1447**



300/3000's Orbital Unit  
C/W Release Valve  
100 osp m20

**6907**



300/3000's Orbital Unit  
C/W Release Valve 125  
OSP m18

**4655**



Orbital Unit 2/5/600's  
Orbital Unit C/W Rel.  
Val. 3/4' JIC 100 OSP

**4564**



Orbital Unit Seal Kit to  
Suit 4655

**4605**



Orbital Unit (Valve)  
Ford 40 series & TS 4 W/D  
Orbital C/W Release Valve  
150 osp m18

**51051**



Orbital Unit  
C/W Release Valve  
200 OSP 3/4 JIC

**4857**



John Deere Orbital Unit  
C/W Release Valve  
160 osp 3/4' JIC

**1504266**

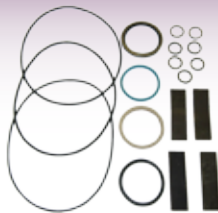

Orbital Unit Repair Kit  
IHC/Massey Ferguson/  
DB

**4620**



Zetor Orbital Unit  
C/W Release Valve  
160 osp m20

**4600**



750mm Steering Wheel,  
Core Column Hydrostatic

**62292**



Orbital Unit Fitting  
Kit 675 -698 French Type  
2 x Screw & 4 x O Ring 575 - 590

## Cab Components

### Bonnet Spring

2116

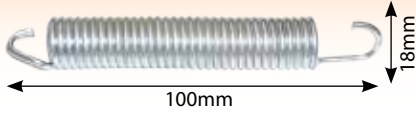

Zetor Bonnet Spring

### Bonnet Mounting

883622

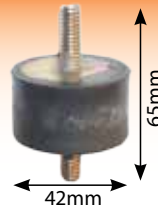

Bonnet Mounting

### Tank Mounting

2185

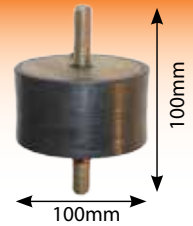

Tank Mounting

### Door Handle

5073



Zetor 8011 Inside Door Handle

5129



Zetor 8111 L.H./R.H. Outer Door Handle

5061



Zetor 8111 R.H. Door Lock

### Door Lock

5183



Zetor Bellow for Seat

5105



Zetor 8011 Rev counter Clock

5056



12011 Speedo Cable

5101



Decal Zetor 8011 Special

### Gas Struts

#### Note:

Check newton rating of existing gas strut before ordering a replacement. Using a gas strut with a lower or higher newton rating can result in damage or glass breakage.

3658



Gas Strut Zetor Short - 175N  
320mm x 170mm

3659



Gas Strut Zetor Long - 180N  
410mm X 210mm

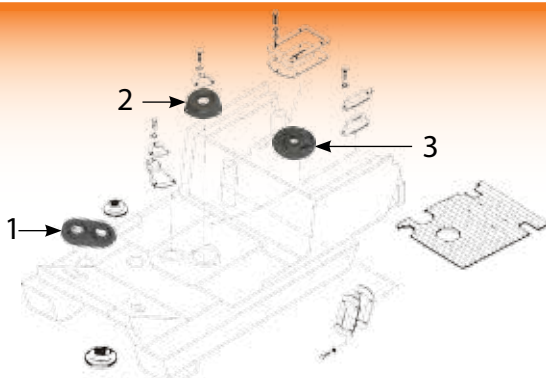

1. **5092** 8011 Brake Pedal Seal Zetor
2. **5090** 8011 Gear Lever Seal Zetor
3. **5094** 8011 Lift Drop Variator Seal Zetor

## Weights & Mudguards

**1488**



Mudguard  
Trailer Tandem 8" x 60" Pair

**1496**



Mudguard Trailer 13"  
Wheel Pair

**2993**



Mudguard Kit Front  
3060/3070 320mm 2WD

**2991MP**



Mudguard  
Mounting Plate

**51086**



Case 956/1056  
400mm Front Mudguard Kit

## Tractor Mudguard Flaps

**Tractor Mudguard Flaps  
Sold as Pairs**

**Note:** All measurements are +/- 15mm due to the nature of manufacturing process



**2969**  
**402947**  
**402948**  
**2436**  
**2968**  
**2959**  
**2960**

A: 350 mm, B: 1000mm  
A: 380 mm, B: 1140mm  
A: 480 mm, B: 1160mm  
A: 320 mm, B: 960mm  
A: 400 mm, B: 1225mm  
A: 540mm, B: 1320mm  
A: 600mm, B: 1340mm

## Cab Components Lamps

**7161**



Zetor 5011-7745  
L.H. Headlamp

**7162**



Zetor 5011-7745  
R.H. Headlamp

**7158**



Zetor 5211-7745  
Side Light

**5050**



Rear Lamp Lens  
Zetor Crystal

**7157**



Zetor 5211-9540  
Side Lamp Lens

## Work Lamps

**2324**



Work Lamp Cab H3  
Single Mounted

**3179**



Work Lamp  
H3 12V

## Indicator Switch

**5314**



Indicator switch  
for Zetor crystal

## Grills

**7151**



Zetor 5211-7745  
L.H. Side Panel

**7153**



Zetor 5011-7011 Grill with  
Lamp Holes

**7154**



Zetor  
5211-7745  
Upper Grill

# Cab, Sheet Metal & Electrical

## Electrical Components

### Starters

**5146 RH UR1**



Zetor 6718/5711/7245  
Starter UR 1

**5147 RH UR2**



Zetor 8011/8111 UR2  
Starter Zetor

**5145 LH UR3**



9540 Zetor  
Starter UR 3

**5173 LH ZTS**



Zetor ZTS  
Range Starter

### Solenoid

**1264**



Cap  
To Suit 1927

**3318**



Zetor Ignition  
Switch

**2504**



Zetor Ignition  
Switch Key

**5018**



Oil Pressure Switch  
Zetor 5011-7045

**4289**



4 way rotary  
light switch

**4556**



Relay 12v Normally  
Open 40A

**5031**



Zetor 6 Cylinder  
Change Over Switch

### Cut off Switch

**2303**



Lucas cut off  
switch

**2923**



Cut Off Isolation  
Switch - Heavy Duty

**3875**



H/D Isolation Switch  
24V 2500 amp  
(Complete with chain)

**51896**



Key For Cut Off  
Isolation Switch 24V  
2500 Amp HD Suit Our  
Ref 3875

### Warning Light

**1839**



Dash Mounted  
Lamp Warning Amber

**3101**



Dash Mounted  
Lamp Warning Green

**1844**



Dash Mounted  
Lamp Warning Blue

**1259**



Red Warning Lamp  
Dash Mounted

**51091**



Red Indicator LED  
Chrome Housing

**2613**



Warning  
12v 13mm Hole

**1314**



12v Red  
Warning Light  
(13mm Hole)



## Lucas Beacons Magnetic

**51182**



Lucas Magnetic Beacon 12v/24v (Less Bulb)

**51320**



**Lens 51549**  
12v Magnetic Beacon C/O Bulb (Lucas Type)

**4861**



Beacon 24v Large Magnetic

## Xenon Magnetic

**51176**



Magnetic Xenon Beacon (10-30v) (Lucas Type)

**51323**



10-30v Xenon Magnetic Beacon (Lucas Type)

## Flexi

**51321**

**Lens 51549**  
12v Flexi Stem Beacon (Lucas Type)



**59624**

Beacon John Deere 12/24v Flexi Stem



## Xenon

**51332**

Mini Xenon Beacon 12/80v



## Lucas Brackets

**51417**



Beacon Bracket

**3686**



Beacon Bracket

**3687**



Beacon Bracket

**51421**



Beacon Bracket Adaptor

**51387**



Beacon Bracket

**51388**



Beacon Bracket

**51388B**



Bracket Angled for 51388  
Beacon Bracket  
42 43 61 62 81 82

**51388K**

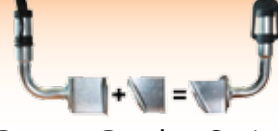

Beacon Bracket Spring Load Including Angled Bracket  
42 43 61 62 81 82

**53093**



Beacon Stem

**51034**



Adjustable Beacon Bracket

**51422**



Beacon Bracket

**3680**



Beacon Plug

**4841**



Beacon Fixing Bracket

## Wiper Motors

**1008**

Kit = 4169



Wiper Motor 12v 110"  
c/w Switch Small  
Tapered  
Shaft length 58mm

**3859**

Kit = 4195

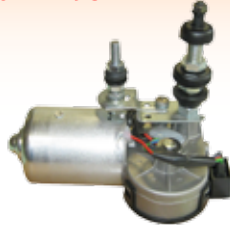

Wiper Motor 12v 90"  
+ Switch Small  
Tapered Shaft length  
58mm

**3860**



Wiper Motor 24v 90"  
+ Switch Small tapered  
Shaft length 58mm

**4169**



Wiper Motor Kit 12v  
110" C/W Arm & Blade  
(Shaft length 58mm)

**4195**

Motor = 3859



Wiper Motor Kit 12v 90" C/W  
adaptable Arm & Blade  
(Shaft length 58mm)

**6671**



Wiper Motor 300's 12v 115"  
Small tapered shaft  
(Shaft length 78mm)

**6645**

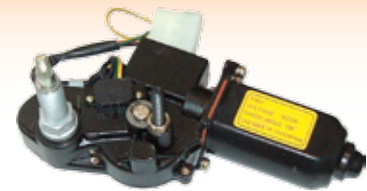

Wiper Motor 390 12v 105"  
Large tapered shaft  
(Shaft length 33mm)

**1563**



Wiper Motor  
Ford Super Q TW5 TW35 10s

**59283**



Wiper Motor John  
Deere 6000 Series

**51027**



Wiper Motor  
John Deere  
12V 90" Large Tapered  
(Shaft length 65mm)

**51061**

Arm = 2207  
Blade = 1619



Wiper Motor 54/61/62/64/  
74/81/82's  
Rear Window  
(Shaft length 33mm)

**51059**

Arm = 2207  
Blade = 1619



Wiper Motor  
105" small shaft  
(Shaft length 48mm)

# Cab, Sheet Metal & Electrical

## Wiper Motors

**41656**

Wiper Motor 12V 120"  
Straight Single Spin  
(Shaft length 99mm)



**51045**

Wiper Motor 12v 110  
Short Stem Straight  
Shaft length 46mm



**2491**

Wiper Motor 12v  
80" Small Tapered  
Shaft (length 58mm)



**2492**

Wiper Motor 12v  
110" Small Tapered Shaft  
(length 58mm)



**51006**

Wiper Motor  
David Brown 12V 95"  
large Tapered Shaft  
length 80mm



**51260**

Wiper Motor 12v 90"  
Small tapered shaft  
With Cover & Switch  
(Shaft 48mm)



**2494**

Wiper Motor 12v 105"  
Small Tapered Shaft  
(Shaft length 94mm)

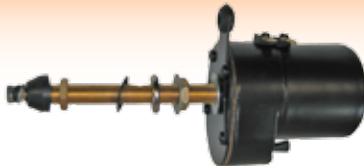

**2493**

Wiper Motor 12v  
85" Small Tapered Shaft  
(Shaft length 94mm)



**51026**

Wiper Motor Case  
12V 115" Small  
Tapered Shaft  
(shaft length 34mm)



**51025**

Wiper Motor Case  
12V 135" Small  
apered Shaft  
(shaft length 34mm)





Search

















# Cab, Sheet Metal & Electrical

## Wiper Arms

Photo	Part No	Motor Type	Description	Length	
				Inches	mm
	<b>4296</b>	Straight Shaft	Wiper Arm	18"	457.2
	<b>2014</b>	Straight Shaft	Parallel Arm	18"	457.2
	<b>2207</b>	Tapered Shaft	Wiper Arm		
	<b>1897</b>	Tapered Shaft	Parallel Arm Blade=1619	19½"	500
	<b>51497</b>		Wiper Arm	15½"	400
	<b>51008</b>		Wiper Arm MF 600's	19½"	500
	<b>2870</b>		Wiper Arm Ford Super Q & Q Cab  Blade=2837	17"	431.8
	<b>4894</b>		Wiper Arm Large Hole	15½" 19½"	400 500
	<b>780036</b>		Wiper Arm Renault TS-TX		

## Wiper Blades

Photo	Part No	Description	Length	
			Inches	mm
	<b>2206</b>	New 1008 Motor		400
	<b>2246</b>	Wiper Blade	17½"	450
	<b>4685</b>	Wiper Blade	24"	609.6
	<b>1619</b>	Suit 1897 Wiper Arm	20"	508
	<b>6753</b>	SUIT 600/3000'S		600
	<b>61941</b>	42/43/61/62/81/82's ALSO 5400 6400 7400 Case Ford DB Fiat Deutz JD Leyland	20"	508
	<b>2837</b>	Ford Q & Super Q Cab John Deere 50's SG2 Cab <b>Wiper Arm =2870</b>		500
	<b>404895</b>	Ford 40 TS TM M		550
	<b>51009</b>	Case XL		650
	<b>62039</b>	Wiper Blade Front J.Deere 6000/10/20 Front and Rear for 50HX		
	<b>59803</b>	Wiper Blade Rear John Deere 6000/10/20		
	<b>780048</b>	Wiper Blade Renault TS/TX		
	<b>62283</b>	Wiper Blade	28"	700
	<b>62351</b>	6200 7200 8200		500

# Cab, Sheet Metal & Electrical

## Cab Glass

### Crystal

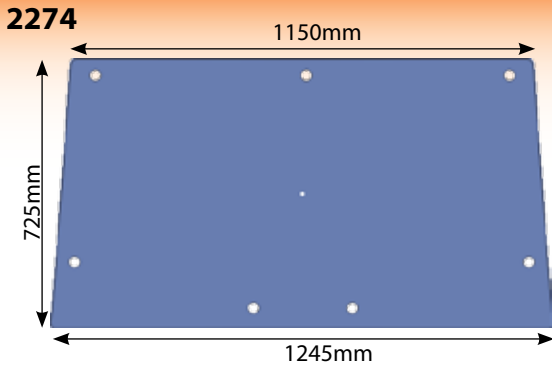

Glass Zetor 8111 Rear Glass (Not Duncan Cab)

### Unified Range

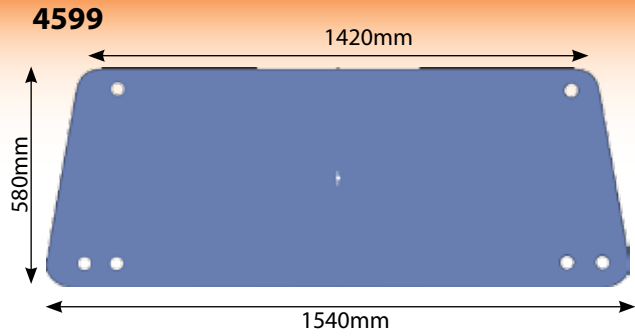

Glass Zetor Unified Rear Window

### 4321-7341

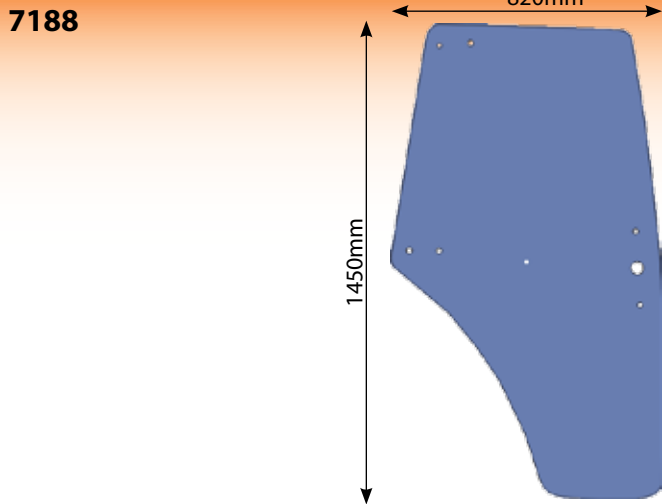

Zetor 4321-7341  
L.H. Door Glass

### 9540-10540

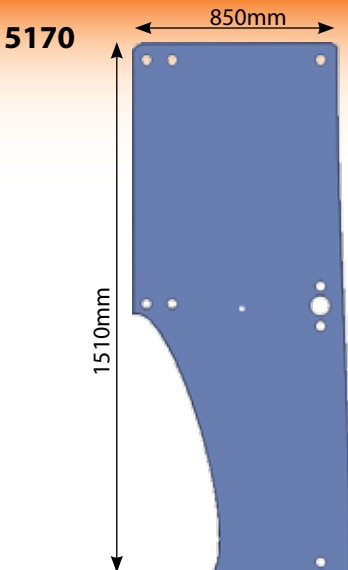

Zetor 9540-10540  
Door Glass

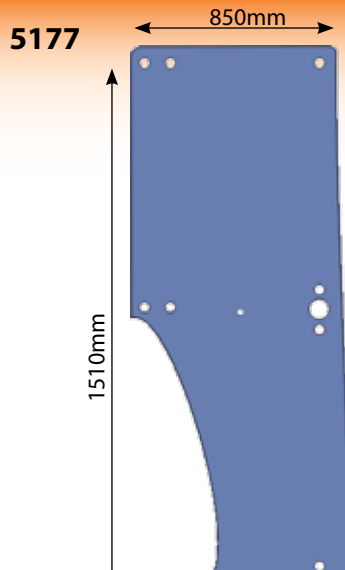

Glass Zetor UR3  
Door 9 Hole

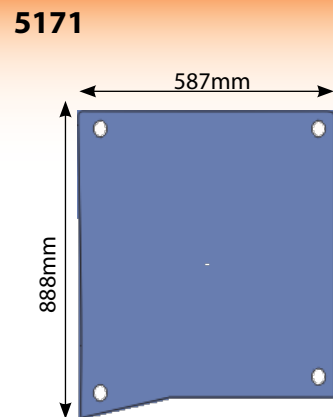

Zetor 9540-10540 Side Glass

## Rubbers Strips and Trims

### All Rubbers Sold Per Metre

**3097**



Beaded Strip 500's (Per Mtr)

**1773**



Beaded Weather Strip

**1774**



Filler Strip for 1773/3097

**1888**



"S" Section Rubber  
(45 mtr per roll)

**3984**



Vinyl Edge Trim  
Sold per Metre

**1285**



Draught Excluder Rubber  
(50 mtr per roll)  
1-3mm Panel Thickness

**51553**



20D Filler Strip (Bubble each  
Side) (10 Mtr Roll)  
Dexta & Major Bonnet

**2548**



300's Weather Strip (PerMtr.)  
1-3mm Panel Thickness

**1407**



Draught Excluder Rubber  
3-6mm Panel Thickness

**51554**



Filler Strip  
(sold in 10 Mtr Roll)

**51555**

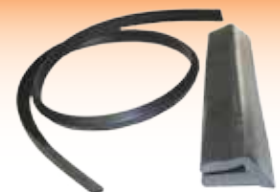

Filler Strip C/O Lip  
(sold in 10 Mtr Roll)

**1427**



Weather Strip Tool

**51227**



Glass Bonding Kit

**51382**



Rubber Section  
(Per Mtr)

**59723**



Seal - JD 20's  
Front Windshield

**53017**



Body Filler  
IsoPON P38 Light-  
weight 250ml

**53018**



IsoPON P40 Glass  
Fibre Repair Paste  
250ml

**53019**



Glass Fibre Repair  
Kit Fastglas

# TRACTOR

# PAINT

Hand brush or spray  
Hardens to an OEM Finish  
No colour variance

**PLEASE NOTE:**  
Use QTP Thinners Only.  
Follow directions on tin.

## For a Professional Finish

**1 Choose Paint**  
Spray or Brush

**Choose**  
From a wide range of colours

**2 TR1488**  
1 Ltr Thinners

**Mixing Ratio**  
Paint : Thinners  
9:1 or 10:1

**3 TR7000**  
1 Ltr Clear Lacquer

**Tough**  
Durable & easy to use

### MASSEY FERGUSON

- TR1200** 35 4 Cylinder Gold
- TR1001** 35 4 Cylinder Red
- TR1180** 35X Ferguson Grey
- TR1187** Massey Ferguson Red
- TR1181** MF 100s Silver Mist
- TR1265** Massey Ferguson Flint Grey
- TR1399** Stoneleigh Grey
- TR1116** Transmission Brown / Charcoal Grey
- TR1000** 42 Series Chassis Black
- TR1002** Massey Ferguson 42 54 Red (New Red)
- TR1004** 42 Series Silver Mist
- TR1179** Smoke Grey
- TR1222** NH Driveline Grey - New Cab
- TR1225** Massey Ferguson Light Grey Pain
- 1191TR** Light Grey

### RENAULT

- TR6615** Renault Grey
- TR6611** Renault Orange

### SAME

- TR5501** Same Blue

### FORD

- TR2440** Fordson Empire Blue
- TR3488** Fordson Orange
- TR1182** Ford Tractor Blue
- TR1071** Ford Grey
- TR1196** New Holland Ford Blue
- TR1220** NH Driveline Dark Grey
- TR1221** New Holland Grey White for Wheels

### FIAT

- TR3130** Fiat Brown
- TR3487** Fiat Opal White
- TR4188** Fiat Terracotta Brown
- TR3131** Fiat Orange
- TR3132** Fiat Cream

### JOHN DEERE

- TR1162** John Deere Green
- TR2134** John Deere Yellow

### LANDINI

- TR1065** Landini Blue

### FENDT

- TR1060** Fendt Green

**53208**  
Grey Primer  
Wheel Spray  
500ml Can



**53207**  
Silver Paint  
Wheel Spray  
500ml Can



**53210**  
Black Paint  
Wheel Spray  
500ml Can



**53209**  
High Gloss  
Black Paint  
Wheel Spray  
500ml Can





# TRACTOR PAINT

Hand brush or spray  
Hardens to an OEM Finish  
No colour variance

**PLEASE NOTE:**  
Use QTP Thinners Only.  
Follow directions on tin.

## For a Professional Finish

**TR1156**



**1 Litre**  
**Red Oxide Primer**

**TR2397**



**1 Litre**  
**Buff Primer Undercoat**

**TR1955**



**1 Litre**  
**Grey Primer Undercoat**

IHC/DAVID BROWN	
<b>TR1163</b>	IHC Off-White Wheels
<b>TR1231</b>	International Red
<b>TR4703</b>	Case/IHC Red New Red
<b>TR3489</b>	David Brown Hunter Pink
<b>TR1184</b>	David Brown Orchid White
<b>TR1184A</b>	David Brown Power Red
ZETOR	
<b>TR1193</b>	Zetor Grey
<b>TR1183</b>	Zetor Red
<b>TR1189</b>	Zetor Chassis Green
LEYLAND	
<b>TR1190</b>	Leyland Light Blue
<b>TR1190A</b>	IHC / Leyland Dark Blue
WHITE/BLACK	
<b>TR2175</b>	Matt Black
<b>TR1109</b>	Gloss Black
<b>TR1420</b>	White

INDUSTRIAL	
<b>TR1520</b>	Old Hitachi Orange
<b>TR1003</b>	New Hitachi Zaxis Orange
<b>TR1185</b>	Industrial Yellow
<b>TR1198</b>	New JCB Yellow
<b>TR1115</b>	New Holland Clayson Yellow
<b>TR1160</b>	New Ford Yellow
<b>TR1192</b>	Komatsu Yellow
<b>TR1194</b>	New Holland Yellow
<b>TR1195</b>	Senator Lime Green
<b>TR1253</b>	Rotavator Orange
<b>TR2393</b>	Case Brown
<b>TR2396</b>	New Cat Yellow
<b>TR2401</b>	Case Tan
<b>TR2447</b>	Kvernland Green
<b>TR3684</b>	Land Rover Blue
NUFFIELD	
<b>TR3490</b>	Nuffield Orange/Red



**Date:**..... **No. of Pages:**.....

**Name of the Rep:**..... **A/C Number:**.....

**From:**..... **e-mail:**.....

**Phone No.:**..... **Fax No.:**.....

Please quote for the following parts - Quotation Number :

I wish to confirm the following order on Quotation Number:

Please supply the following parts:

Please photocopy this page

Please do not remove this page

	Qty	Part No.	Description	Unit Price
1.				
2.				
3.				
4.				
5.				
6.				
7.				
8.				
9.				
10.				
11.				
12.				
13.				
14.				
15.				
16.				
17.				
18.				
19.				
20.				
21.				
22.				
23.				
24.				

**Comments:**  
 \_\_\_\_\_  
 \_\_\_\_\_  
**Customer Signature:** \_\_\_\_\_ **Rep's Signature:** \_\_\_\_\_

Tel No: + 353 44 934 1638

e-mail: [info@qtponline.com](mailto:info@qtponline.com), [www.qtponline.com](http://www.qtponline.com)

Page  of

## Clutches & Components

### 11"

**5150**



Clutch Assembly  
Zetor 11"

**3024**



Clutch Disc Zetor  
11" 18 Splined Organic

**5020**



Clutch Disc Zetor  
11" 16 Splined Organic

**4549**

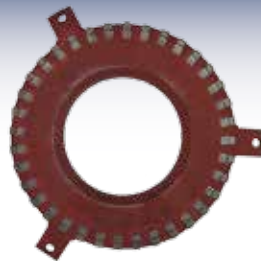

Pressure Plate Zetor  
5011/5211/6011/7011 11"

**5022**



PTO Disc Zetor  
11" 28 Splined

## Individual Clutch Parts

**4547**



PTO Release Lever  
Zetor

**4546**



Drive Clutch Re-  
lease Lever Zetor

**4552**



Thrust Pin Buttons  
Zetor

**4551**



Thrust Pin Zetor

### 12"

**5151**



Clutch Assembly  
Zetor 12"

**4548**

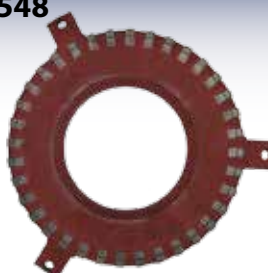

Pressure Plate Zetor  
5011/5211/7011/7045 12"

**5178**



Clutch Drive Plate Ze-  
tor 7745-7340 12"

**7180**

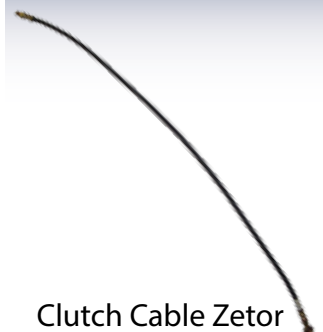

Clutch Cable Zetor  
5211-7745

## Clutches & Components

12"

13"

5178



Clutch Drive Plate  
Zetor 7745-7340 12"

3023



Clutch Disc Zetor 8011 13"  
Organic 18 Spl

3034



Clutch Disc Zetor  
6 Cylinder 22 Spl Bronze

## Individual Clutch Parts

5072



Clutch Spring Fibre  
Washer Zetor 8011

5071



Clutch Spring Zetor  
8011 Inner

5068



Finger Stud Zetor  
8011

5008



Clutch Finger Zetor  
8011

14"

5302

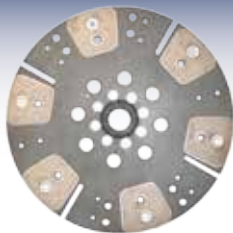

Clutch Disc Zetor 8111/8145  
14" Bronze

5003



Clutch Star Plate  
Zetor 8111

5019



Clutch Release Bearing  
Zetor 8111 Diaph.

15"

5303



Clutch Disc Zetor 12111/12145  
Main Drive 15" Organic

5304

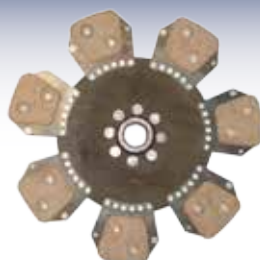

Clutch Disc Zetor  
12111/12145 15" Sintered

5023



Star Plate Hub Zetor  
6 Cylinder

## Clutches & Components

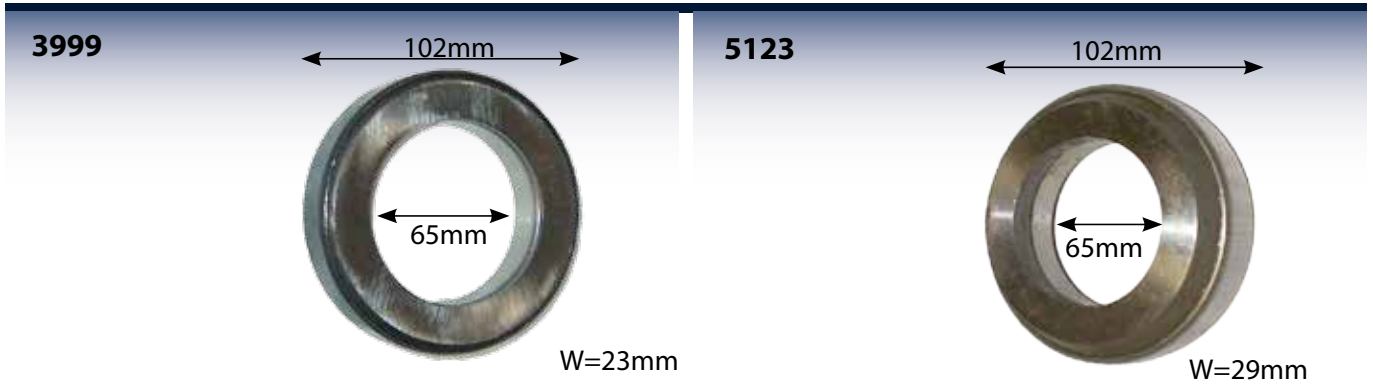

**3999**  
Clutch Release Bearing IHC / Same  
Same Falcon/Leopard 85/90/95/  
Jaguar 95

**5123**  
Release Bearing  
Zetor 5211-7245



**51122**  
Clutch Bearing Zetor

**5019**  
Clutch Release Bearing  
Zetor 8111 Diaph.

**6304ZZ**  
Zetor 11" Spigot Bearing



**7173**  
Zetor 5211-7745  
Clutch Slave Cylinder

**5176**  
Clutch Slave Cylinder Zetor  
9540

## Brake Components

**5011**



Zetor 8011/8111  
Slave Cylinder R.H.

**5010**



Zetor 8011 Brake  
Master Cylinder

**5012**



Zetor 8011/8111  
Slave Cylinder I.H.

**7170**



Zetor 9540 L.H.  
Brake Slave Cylinder

**5174**



Zetor 9540 Brake  
Master Cylinder

**7171**



Zetor 9540 R.H.  
Brake Slave Cylinder

**2502**



Zetor Brake L.H.  
Slave Cylinder

**2500**



Zetor N/T Short Brake  
Master Cylinder

**2501**



Zetor Brake R.H.  
Slave Cylinder

**2507**



Zetor Master  
Cylinder Piston

**7124**



19mm Cup Seal  
To Suit 2507

**2115**

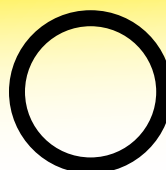

Zetor Crystal  
Master Brake  
Cylinder Washer

**2153**

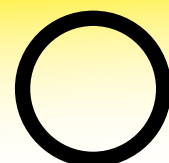

Zetor Slave Cylinder  
'O' Ring

## Brake Components

### Brake Pipes

**5015**



8011 R.H. Brake Pipe

**5014**



8011 L.H. Brake Pipe

**5121**



6011/6045/7011/7045  
R.H. Brake Pipe

**5122**

6011/6045/7011/7045  
L.H. Brake Pipe



**7160**

8011 Master Cylinder  
Feed Pipe



**5054**



Zetor 8011 Hand Brake Cable

**7168**



Zetor 5011-7045  
Return Spring for Brake Shoes

### Brake Shoes

**5158**

Unified Range  
Brake Shoe



**5319**

Brake Shoe Zetor  
3 Cylinder (Small)



**5111**

Brake Actuator  
Zetor 8011



**5306**

Brake Disc Zetor  
8111 Complete  
13 mm Overall Thickness



**5085**

Brake Dust Cap  
Zetor 8011



**5133**

Crystal Large  
1/2 Shaft Seal



**5132**

Crystal Small  
1/2 Shaft Seal



**16779X**

Brake Actuator Ball  
7/8"



**1005510**

Spring Brake Actuator  
165 Ford 7840 Square



## Brake Components

**4203**

Zetor 8011  
P.T.O. Spigot Shaft



**5162**



P.T.O. Brake  
Piston

**5152**



P.T.O. Spring 12 Per  
Tractor

**5025**

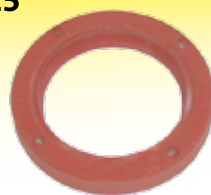

Zetor 8011  
P.T.O. Seal

**5026**



Zetor P.T.O. Seal

**5161**  
Crystal P.T.O. Plate Steel

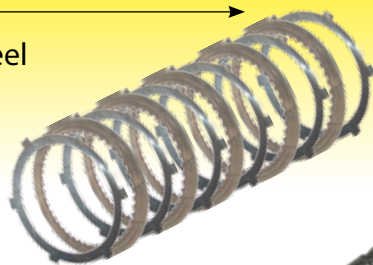

**5190**  
PTO Seal Zetor  
Crystal

**5109**  
8011 IPTO/P.T.O.  
Housing 'O' Ring

**5118**  
Zetor 8011  
Small Cuff Seal

**5117**  
Zetor 8011  
Cuff Seal

**5007**  
Zetor 8011  
P.T.O. Shaft

**5051**  
Zetor P.T.O.  
circlip

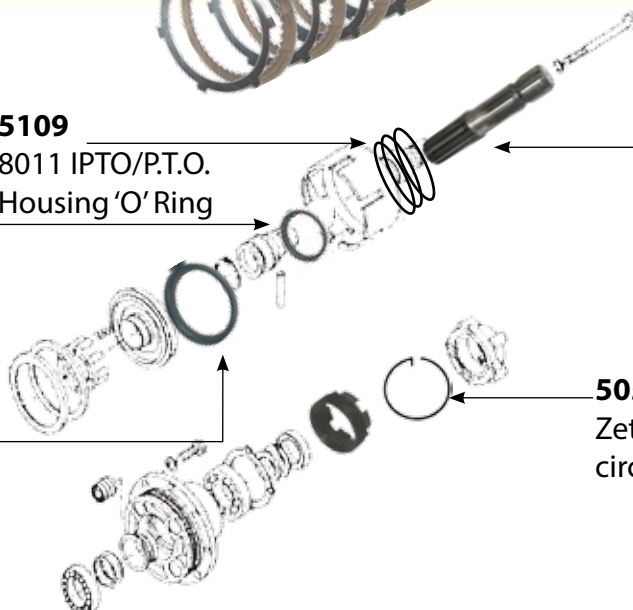



## Torque Components

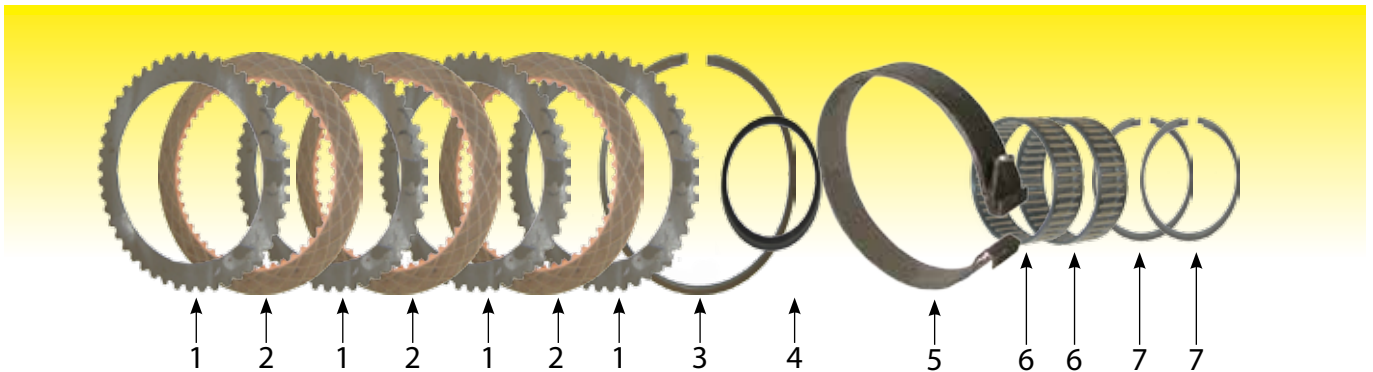

- |    |             |                   |    |             |                        |
|----|-------------|-------------------|----|-------------|------------------------|
| 1. | <b>5052</b> | Steel Disc        | 5. | <b>5112</b> | 8011 Torque Brake Band |
| 2. | <b>5046</b> | Ipto Clutch Plate | 6. | <b>5045</b> | Caged Roller Bearing   |
| 3. | <b>5063</b> | 8011 Piston Ring  | 7. | <b>5057</b> | Ring For Torque Pump   |
| 4. | <b>5049</b> | Sealing Ring      |    |             |                        |

**5130**

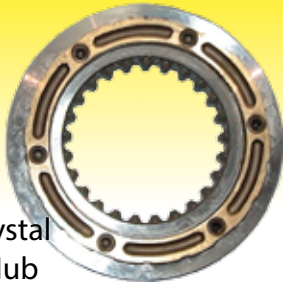

Zetor Crystal Torque Hub

**5080**



Gear Box Selector Zetor 8011

**5103**



Gear Lever Zetor 8011 (Rev+1+2)

**5066**



Front Housing Torque Zetor 8111

**5065**



Torque Pump Zetor 8011

**5192**

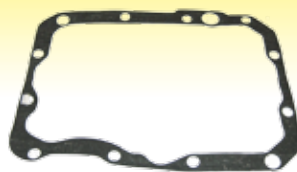

Gasket Zetor Gear Box Diff Casing

**5079**

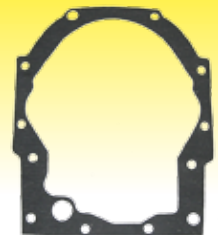

Gasket Zetor 8011 Centre Housing

## Hydraulics Pumps & Components

**1983**



Crystal Hydraulic Pump

**2050**



Zetor 6718 Hydraulic Pump

**5175**



Zetor 9540 Hydraulic Pump

**53118**



Hydraulic Release Valve Zetor Unified Range

**53119**



O Ring for Housing Zetor Unified Range

**53120**

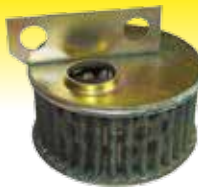

Hydraulic Filter Zetor Unified Range

**53121**

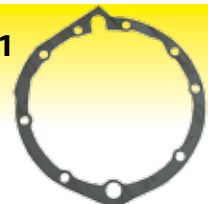

Gasket Hydraulic Pump Zetor Unified Range

**5115**



Zetor Lift Assistor Ram Piston

**59649**



Stabiliser Zetor Forterra H Duty

**5104**

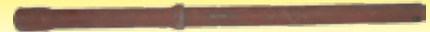

Zetor 8011 Levelling Box Tube

**5038**



Crystal Shaft For Hydraulic Pump

**5108**



Lift Arm Pin Zetor 8011

**5076**



Nut For Pin Zetor 8011

**5095**



Lift Cylinder Zetor 8011

**5097**



Piston Collar Zetor 8011

**5075**



Piston Ring Zetor 8011 95 x 3

**5096**



Lift Piston Zetor 8011

## Linkage CBM Type

**41740**

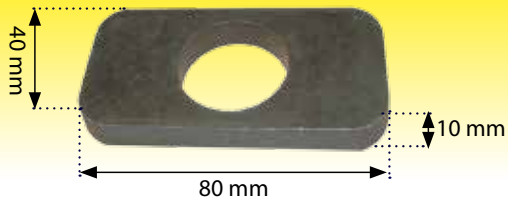

Bottom Fork Plate CBM  
Type 28.5mm hole

**41741**

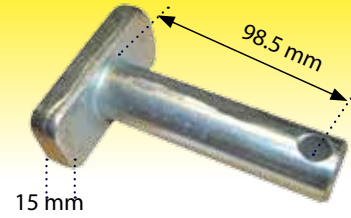

Bottom Fork Lift Link Pin  
CBM Type 28.5mm

**41742**

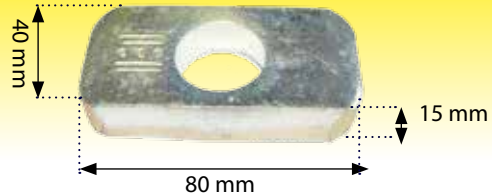

Bottom Fork Plate CBM  
Type 25.5mm

**41743**

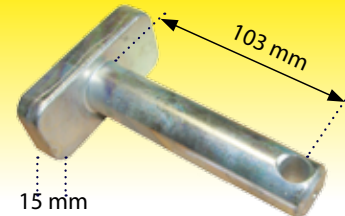

Bottom Fork Lift Link Pin  
CBM Type 25.5mm

**41744**

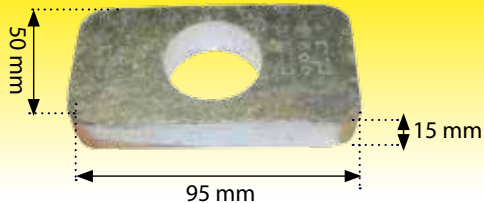

Bottom Fork Plate CBM  
Type 32mm hole

**41745**

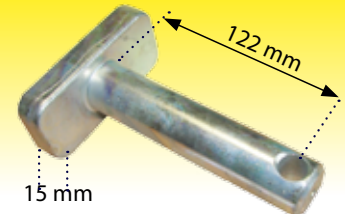

Bottom Fork Lift Link Pin  
CBM Type 32mm

**41747**

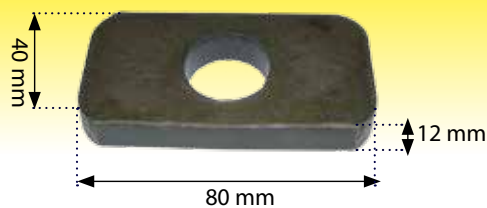

Bottom Fork Lift Link Pin  
CBM Type 22mm

**41748**

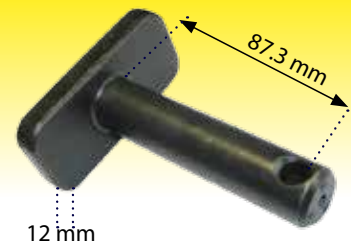

Bottom Fork Plate CBM  
Type 22mm

## Dromone Hitch Components

**DRA2414**

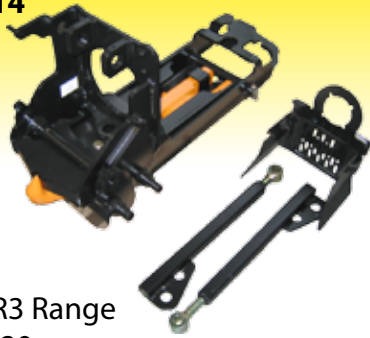

Zetor UR3 Range  
8540-9520

**DRP79052**



Lift Rod For Zetor UR3

**DRP44340**

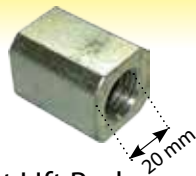

Nut Lift Rod  
20 mm

**DRP44341**

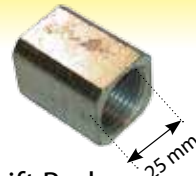

Nut Lift Rod  
25mm

**DRP43206**

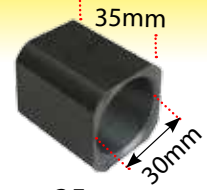

Spacer 35mm  
High

**DRP47902**



Tow hook (80mm)

**DRSP30293G**

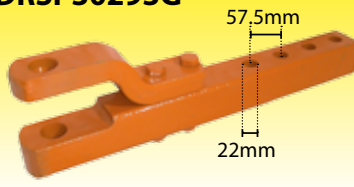

Drawbar Assembly ISO

**DRSP30293**

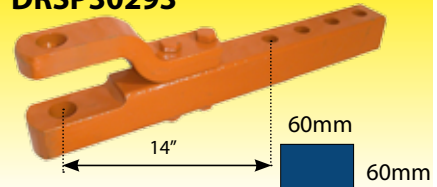

Drawbar Assembly ISO

**DRP75272P**



Zetor Lift Rod Ass uri

**DRSP30312**



Dromone Hitch  
Hydraulic Release  
Ram Overall Length  
9 1/4" 23.5cm

**DRP59000**



Standard Pull Cable  
For All Dromone Hitches  
(1820 mm)

**DRP48715**



Hinge Pin  
325mm long 25.2mm thick

**DRP48810**



Drop In Pin

**DRP48832**



Drop In Pin

**DRP48818**



Drop In Pin